



A DAY AT THE FARM



This book is a result of a project collaboration between Sweden's 4H and National Veterinary Institute (SVA).

Illustrator: Signe Lundqvist

DRAW ANIMALS

Here at the farm you can meet many different animals.

Draw the animals you think you can find here.

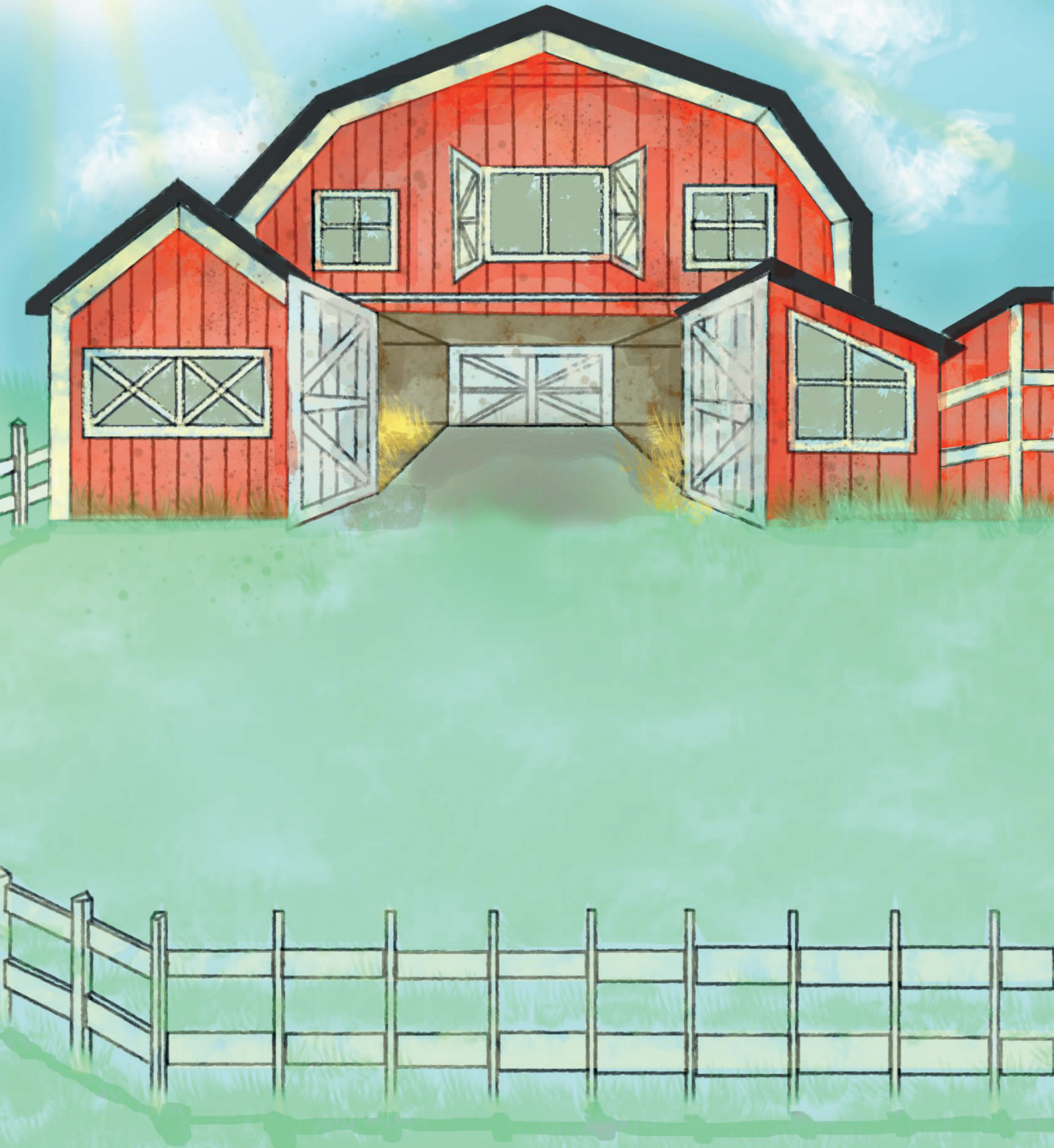

FIND THE HIDDEN WORDS

Eight animal species that could be found at a farm are hidden in the box of letters.

The words are hidden horizontally, vertically and diagonally. Can you find all of them?

HINT!

In this box you can find the animals you are looking for →

CAT
COW
GOAT
HEN
HORSE
PIG
RABBIT
SHEEP



T	U	S	C	O	W	J	L
B	R	C	H	O	R	S	E
N	P	A	I	E	A	O	C
W	Y	T	B	U	E	R	P
G	D	L	K	B	Q	P	H
O	T	B	R	S	I	E	E
A	O	P	I	G	S	T	N
T	I	U	X	V	F	H	Z

MAZE

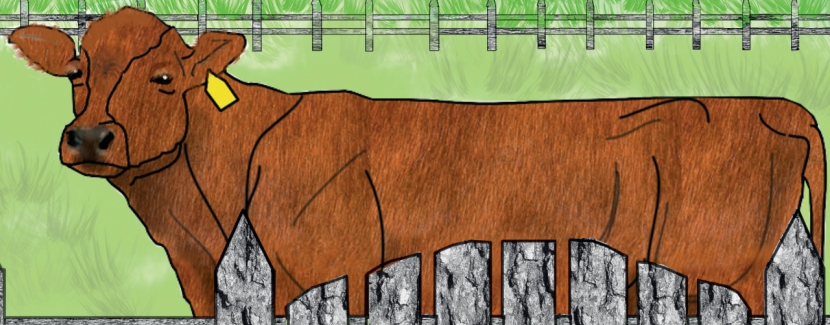

Can you find the way to me through the maze?

On the way you need to pass the soap and wash your hands!

FINISH

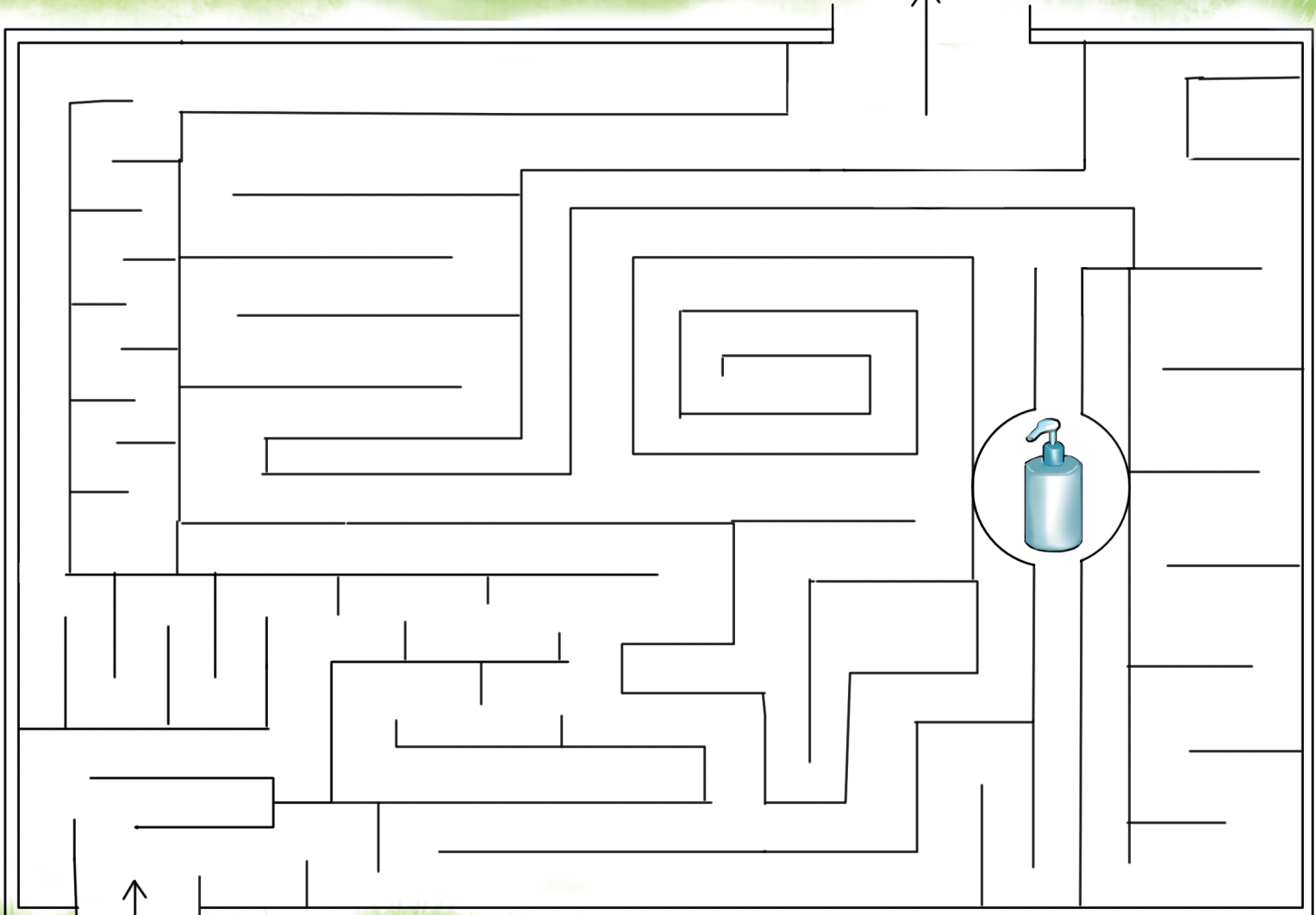

START



PICTURE PUZZLE

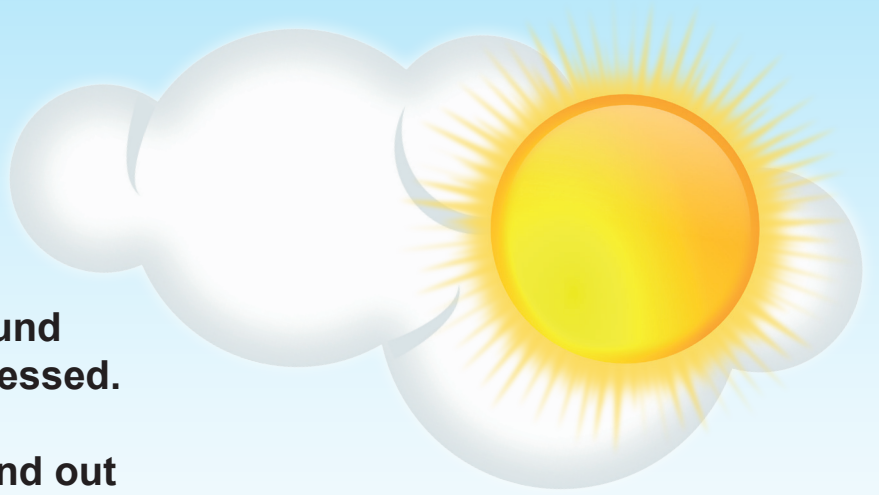

It's important to be calm around animals so they don't get stressed.

Solve the picture puzzle to find out what the animals need.

_____ + _____ + _____

SCRAMBLED PICTURE

Can you try to recreate the picture of the pig?

On each piece of the broken pig picture there is a letter. Figure out which number in the intact picture that matches with the right piece in the broken picture. Insert the letter in the row below. When all the letters are taken you will be able to see what the pig wants: It's important...

T	1	2	3	4	5	6	7	8	9
---	---	---	---	---	---	---	---	---	---

TO ALL ANIMALS

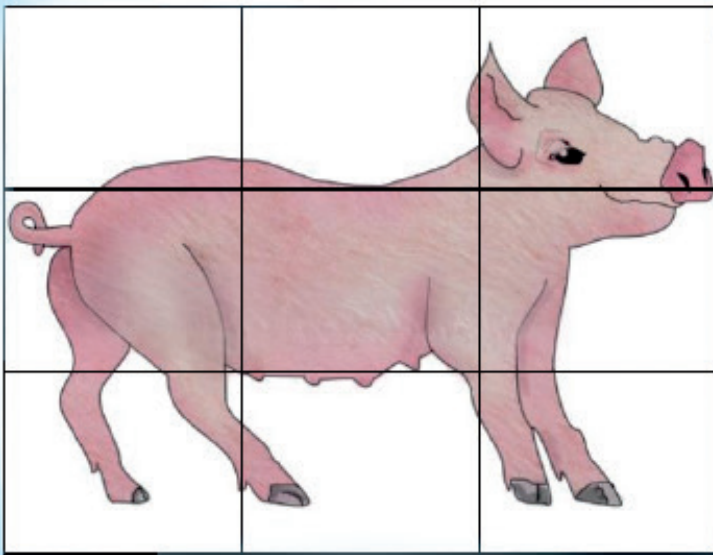

1	2	3
4	5	6
7	8	9

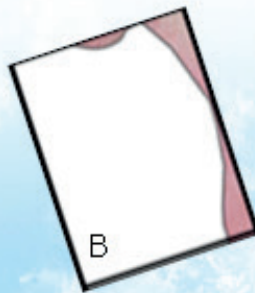

FIND SOAP

Apparently, the farm has run out of soap, just before lunch time!
All visitors need to wash their hands before having a meal.

Help the staff find the five hidden soaps in the tool shed. Draw a circle around the soaps that you find.



HINT!

The soap you are looking for
looks like this





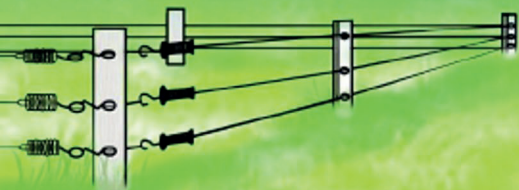





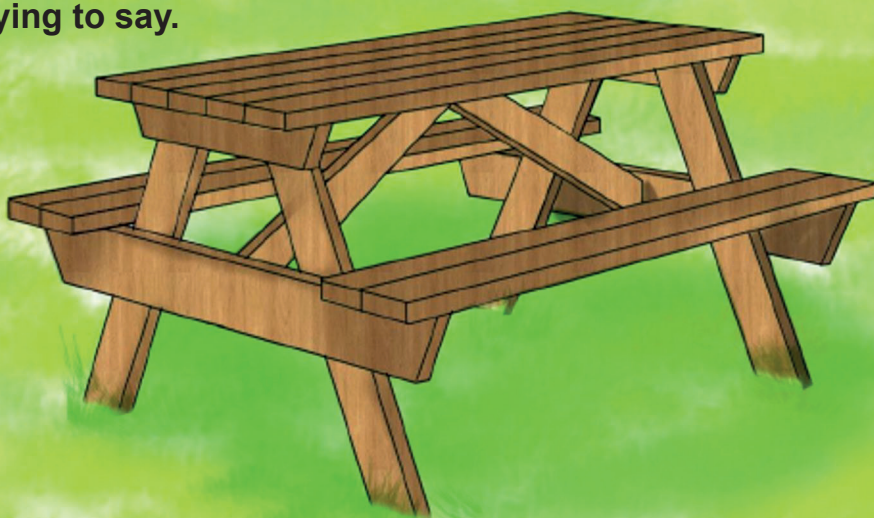















CROSSWORD



The table is a
 _ _ _ _ place to eat
 1 2 3 4 by!

Solve the crossword puzzle and insert the three missing letters in the bubble from the numbered boxes in the crossword. You will then be able to see what the child is trying to say.



														
														
									1					
				4										
	2	3												
														
														

DOT TO DOT

It's always important to pick up your trash so that animals won't eat something that would make them sick.

Draw from dot to dot, start from 1 and finish at 19 to find out where the child is throwing the apple leftovers.

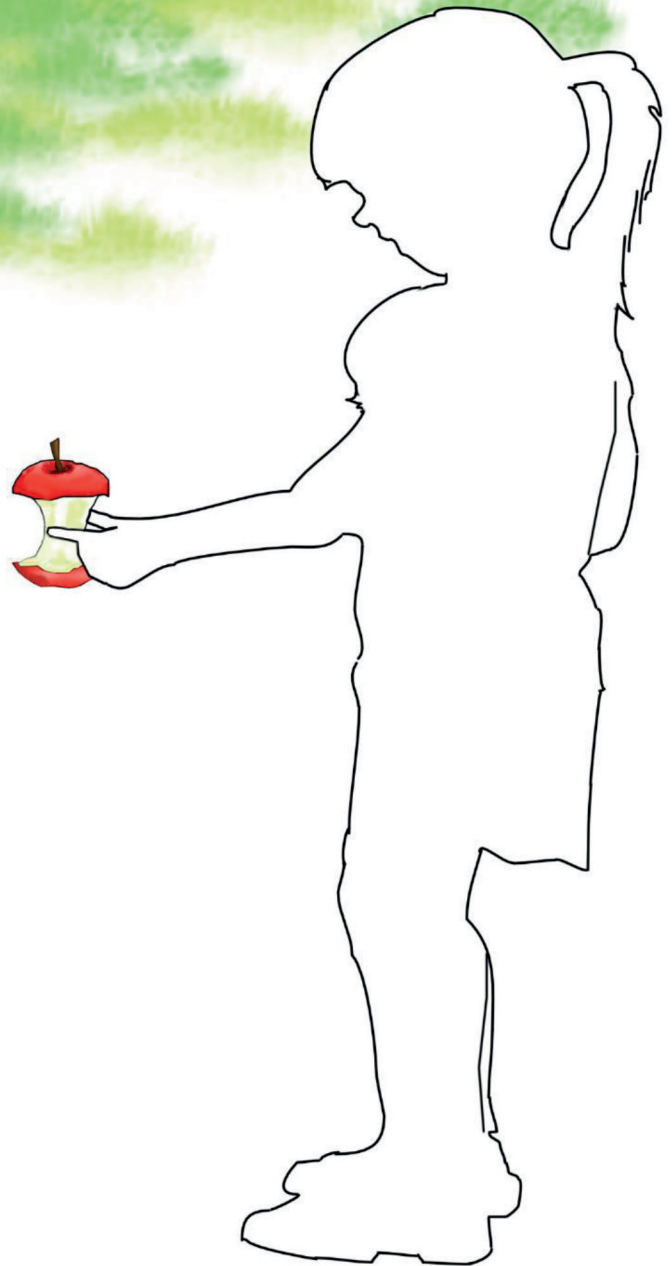
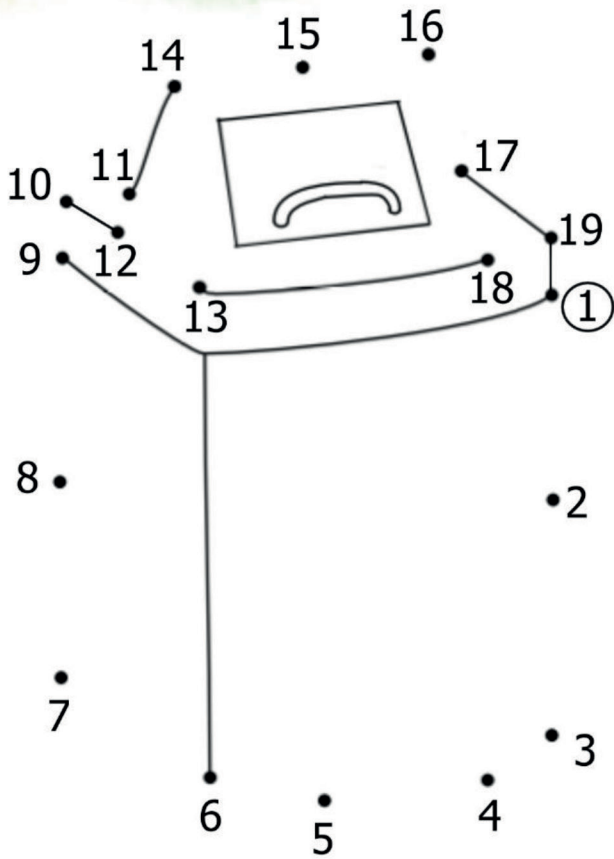
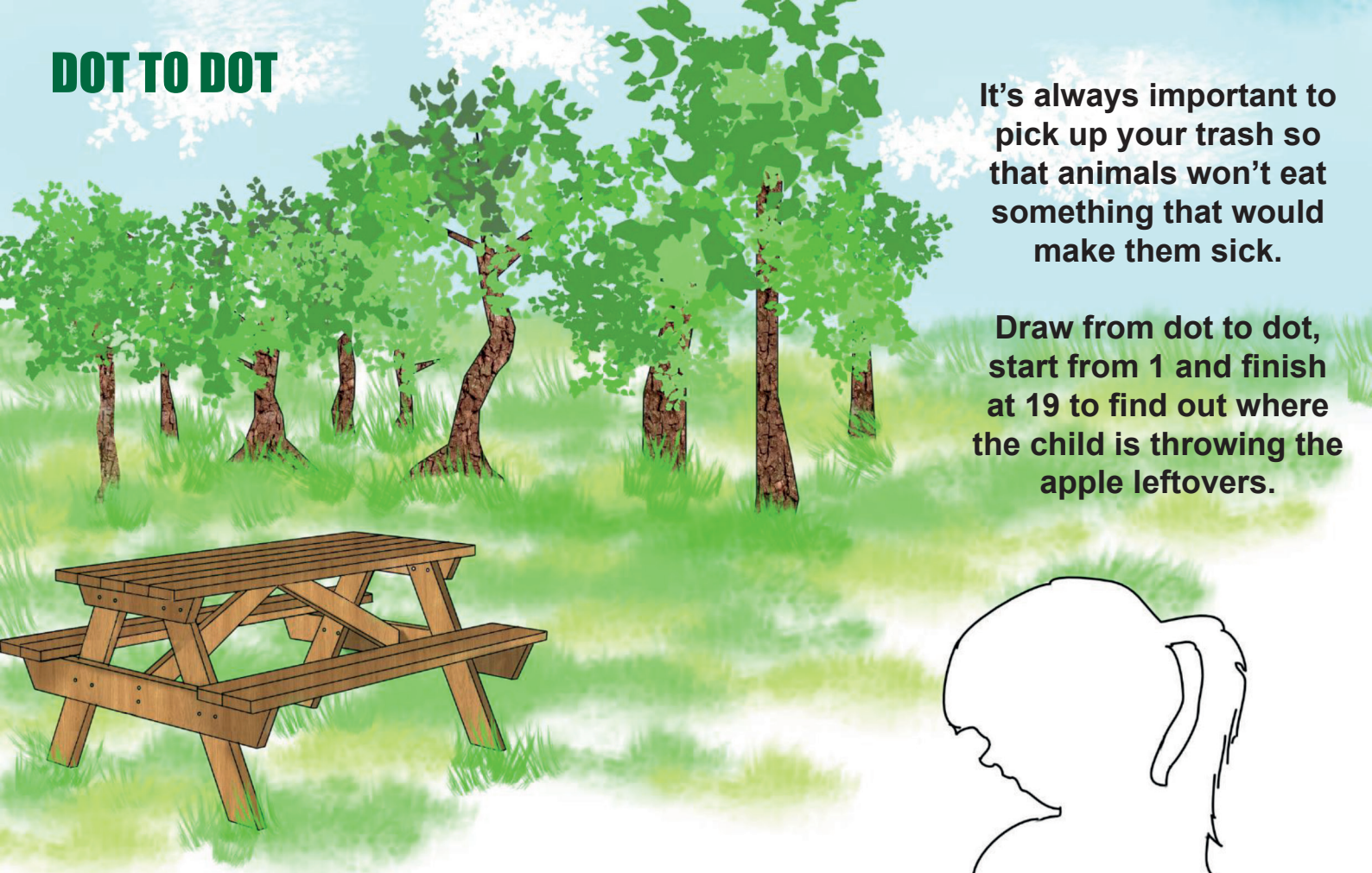

WHAT DID I LEARN TODAY?

Describe your day at the farm.

